



# VOID PLATFORM SYSTEM

## INSPECTION HANDBOOK



**1300 181 183**  
[www.scafeast.com](http://www.scafeast.com)

## IMPORTANT NOTICE

Telescopic Brace had been registered the design under IP Australia. Newness and distinctiveness are claimed in the feature of shape, configuration, pattern, and/or ornamentation. Ezy Deck Australia will retain the right to pursue legal actions against any copy right infringements.

## INTRODUCTION

The purpose of this Handbook is to help you well inspect an installed stair void platform before put it into use.

As we all know, stair void system plays a critical part in the construction industry, it protects individuals from falling down uncovered voids to prevent injury or even death that might happen. This Handbook illustrates information you will be needing to well inspect the void systems in order to prevent them from collapsing and injuries related.

It must be installed by authorised installer and must be signed off once installed to make it safe for use.

Under no circumstance is it allowed to amend or revise the void system installed and signed off by authorised person, removing components or adjusting the system, for the purpose of getting bulky materials through the void, may cause serious danger as the person conducting this process may be not authorised.

Here are some potential risks of amending or adjusting the void system:

- \* Components may be wrongly used or installed when putting them back together.
- \* Some key areas of the platform are not secured.
- \* Configuration of Stair void system may not be put back as they should be.

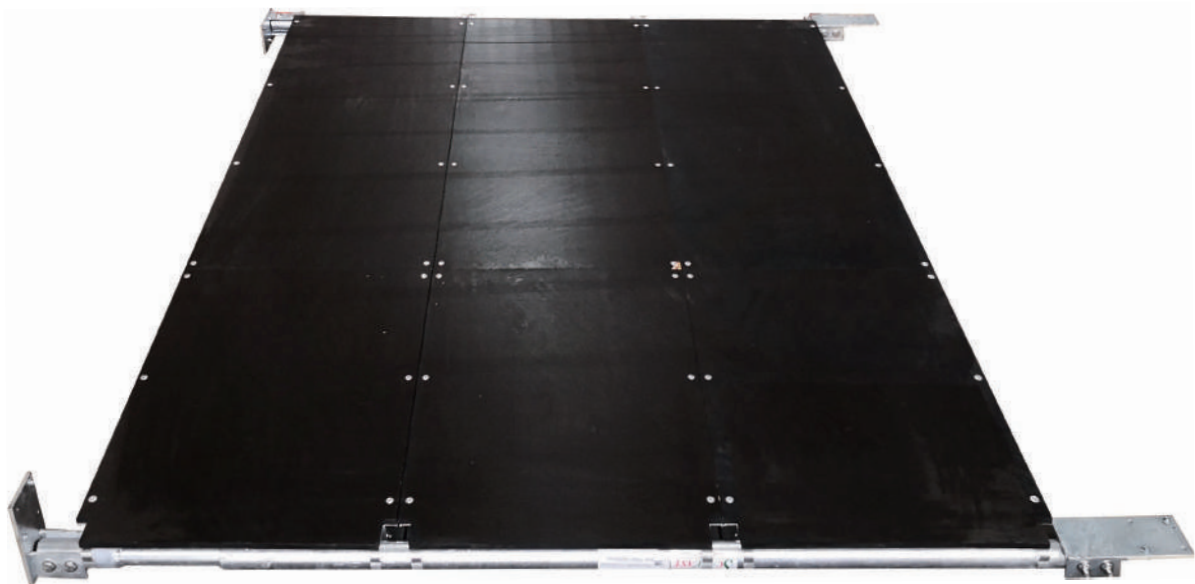

# INSPECTION CHECKLIST

Conduct installation audits by using the installation checklist below and refer to the Handbook for any further information, Buildsafe should be contacted when required. Please put N/A in Yes field for questions not applicable.

## SCAFEAST VOILD PLATFORM CHECKLIST 2018

Construction company name:	
Site Address:	
Installer:	

### Signage

1. See if the sign "Light Duty Platform" positioned at the access point or at the top ladder rung?
2. Access point has the sign "Handover Certificate" attached to it?

### Installation details

3. Check if all the extension braces have at least 50mm gap onto the floor?
4. Do you use #14 screw and have 65mm embedment?
5. Are all the extension braces structurally sound?
6. Are all brackets installed correctly to ensure framing is solid?
7. Do all the extension braces have at least 20mm distance from the "L" bracket?

### Platform

8. Are the gaps to the wall no bigger than a maximum 225mm?
9. Check if the distance between platform and floor is less than 100mm.
10. Are all platform decks positioned correctly onto the extension braces?
11. Are the gaps less than 10mm between decks?
12. Any damaged part on the platform decks?
13. Any substituted material used as platform decking (e.g. chip board)
14. Any safe access and egress to the void platform?

### Ladder access

15. Is the access ladder installed at an angle between 70 - 80?
16. Is the access ladder extended at least 900mm past the platform?
17. Any ladder bracket installed to prevent slipping or moving?

Note:

Signature:

Date:

# SIGNAGE



**Make sure there is a sign at the access point or attached onto the ladder telling you there is a Void Platform?**

Temporary Void Platform light duty sign is essential to all Buildsafe void platforms, make sure there is one attached to the ladder or to any steel that is obvious for people to notice.

A Handover certificate, which is attached to Void Platform, is also essential to all Buildsafe platforms, make sure there is one and is obvious enough for people to notice.

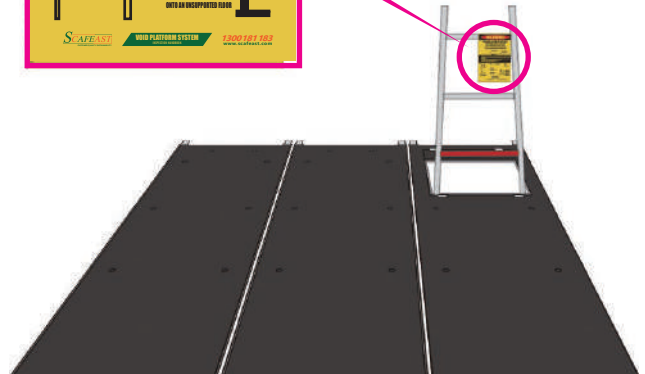
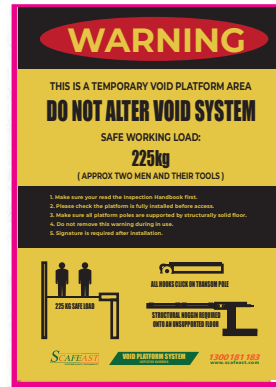

**Make sure there is a Handover Certificate attached at access point.**

INSPECTION CHECKLIST					
<p>Customer installation works by using the installation checklist below and refer to the handbook for any further information. Checklist should be completed with approval. Please call 1300 181 183 for the details of this work.</p> <p><b>SCAFEAST VOID PLATFORM CHECKLIST</b> 2018</p> <table border="1"> <tr> <td>Inspector</td> <td></td> </tr> <tr> <td>Date</td> <td></td> </tr> </table>		Inspector		Date	
Inspector					
Date					
<p>1. Make sure there is a sign at the access point or attached onto the ladder telling you there is a Void Platform?</p> <p>2. Make sure you read the Inspection Handbook First before installation and access.</p> <p>3. Make sure all platform edges are supported by structurally solid floor.</p> <p>4. Make sure all platform edges are supported by structurally solid floor.</p> <p>5. Make sure voids are smaller than 1m x 1m for being unobstructed.</p> <p>6. Make sure the gap between platform and ground is less than 20mm.</p> <p>7. Make sure the gap between platform and ground is less than 20mm.</p> <p>8. Make sure all platform are placed carefully and ensure safe so that all steel feet are on the ground.</p> <p>9. Check if there is any other material used on platform during the installation.</p> <p>10. Make sure all steel are not damaged and in a good condition.</p> <p>11. Check if there is any other material used on platform during the installation.</p> <p>12. Make sure the access ladder is installed at an angle between 75° to 90° degrees should be 45°.</p> <p>13. The void platform should be installed on a level surface.</p> <p>14. Ladder which should be installed in a safe manner on a stable.</p>	<p>1</p> <p>2</p> <p>3</p> <p>4</p> <p>5</p> <p>6</p> <p>7</p> <p>8</p> <p>9</p> <p>10</p> <p>11</p> <p>12</p> <p>13</p> <p>14</p>				
<p>Signature: _____ Date: _____</p> <p><b>SCAFEAST VOID PLATFORM SYSTEM 1300 181 183 www.scafeast.com</b></p>					

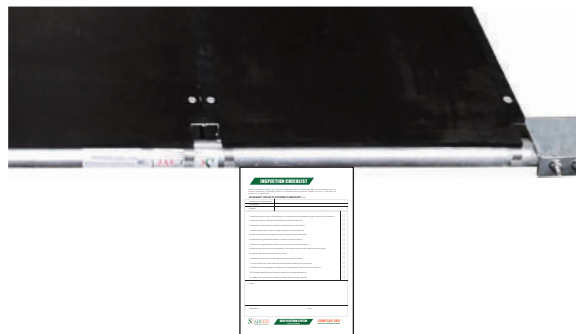

Access to the platform must be prohibited when there is no Handover Certificate.

# FIXING DETAIL

## ✓ Make sure all Poles have at least 50mm overhang onto a solid surface.

If decks are placed onto the floor, then noggins must be used to avoid sideway movement in the platform decks.

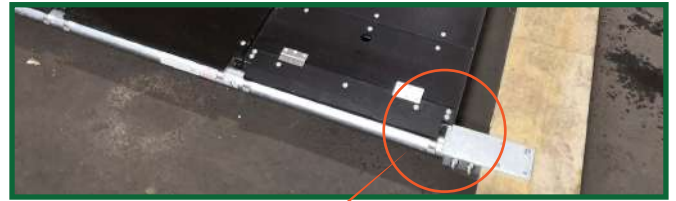

## ✓ Make sure all platform poles are supported by structurally solid floor.

The Floor Tongue should be placed onto a structural Noggin installed on supported flooring when it is installed onto an unsupported floor.

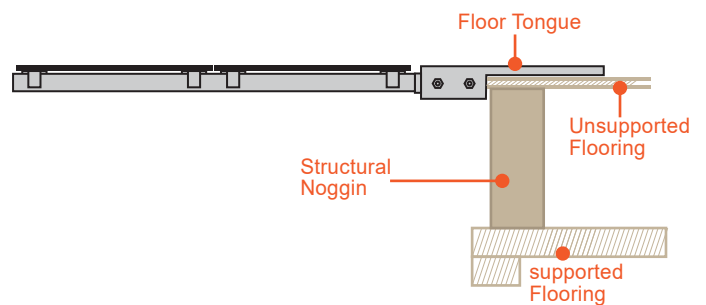

## ✓ #14 Screw 65mm embedment.

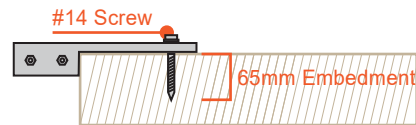

## ✓ Make sure brackets are installed correctly to keep framing undisturbed.

## ✓ Make sure the gap between platform and floor is less than 100mm.

## ✓ Make sure the gap between platform and vertical walls is less than 225mm.

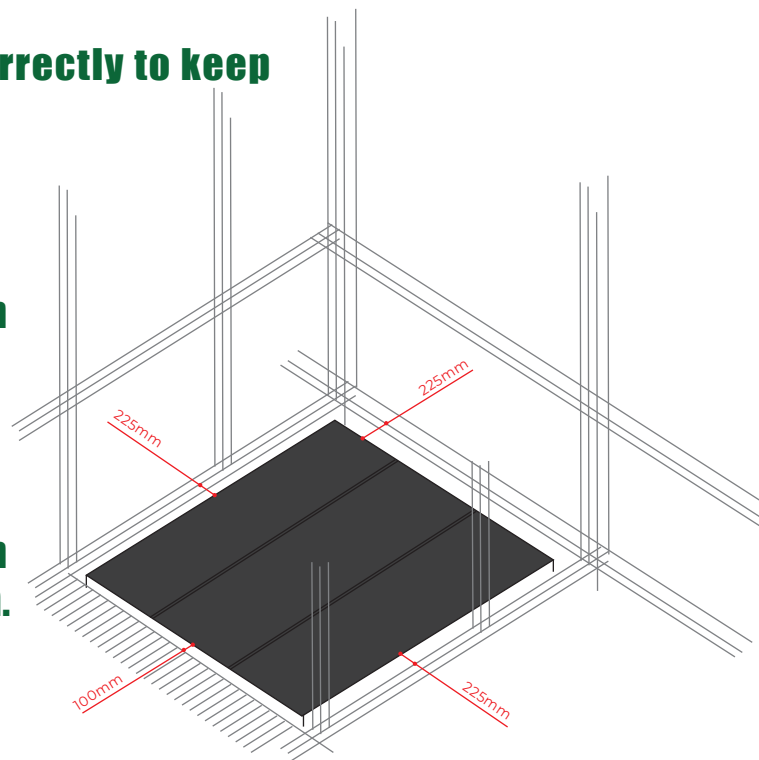

# PLATFORM

**✓ Make sure all platforms are placed perfectly onto transom pole so that all deck feet click on pole.**

If the decks run onto the floor then check if all deck hooks sit correctly onto floor steel.

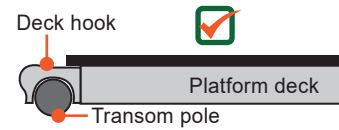
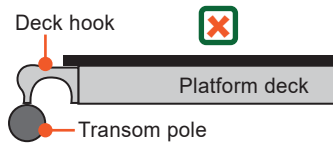
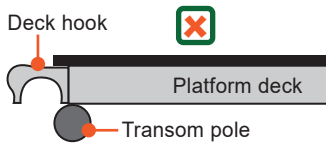

**✓ Gaps between decks must be less than 10mm.**

Check that the gap between the Platform Decks is not greater than 10mm.

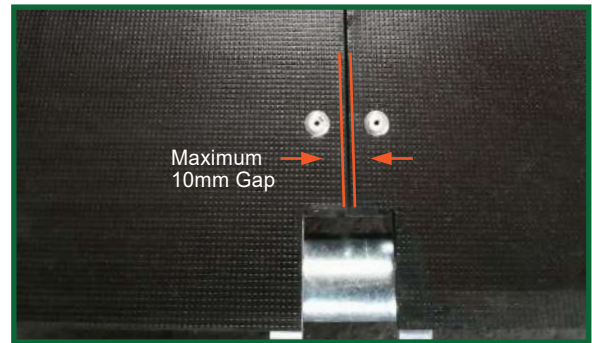

**✓ Make sure all decks are not damaged and are in perfect condition.**

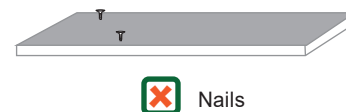
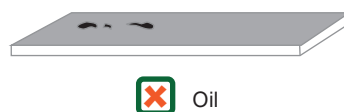
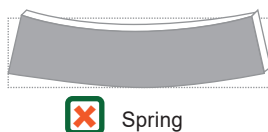
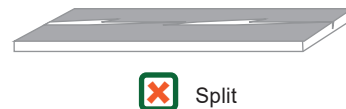
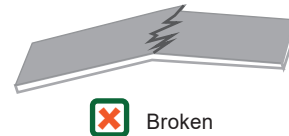
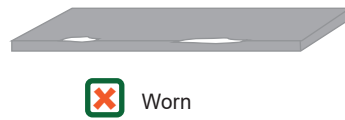
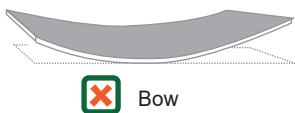

# PLATFORM

Check if there is any other materials used as platform decking, like chip board.

Make sure the access ladder is installed at an angle between 70-80, the ratio should be 4:1.

Make sure the person using the void platform can access to and from ladder without any obstruct.

The ladder installed should extend at least 900mm above the platform.

Make sure ladder projects 900mm from platform.  
Ladder is in perfect and safe condition without any damage.

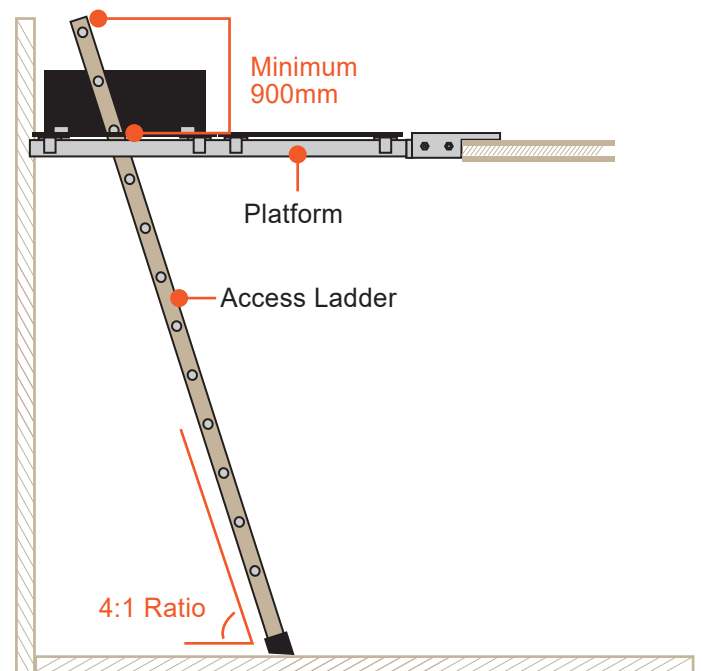

Ladder click lock should be installed to keep it from moving or slipping.

Check if ladder click lock is installed perfectly and allows 4:1 ratio  
The ladder must be locked.

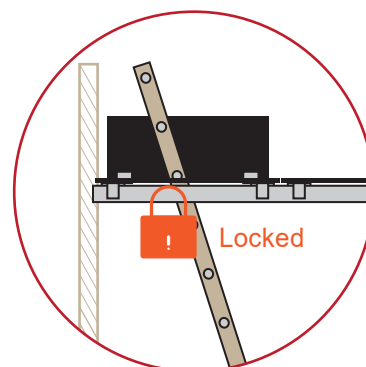

## SUMMARY

### Use the following summary point as a guide when conducting the inspection:

- All the gaps between platform and walls & floor must be within safe range.
- Make sure the L-Bolt is tight and the pole runs 20mm past the saddle.
- All Floor Tongues must be correctly fixed off with right screw and ensure minimum embedment length of 65mm.
- Make sure the Tongue Keeper is sitting as close as possible to the Bottom Plate.
- Gaps between Decks must be less than 10mm.
- Make sure all decks are horizontally level and kept clear.
- The vertical gap between supporting floor and Deck should be more than 50mm when the decks run onto floor.
- Make sure all Deck feet sit perfectly over steel.
- All Decks should be sitting within the Deck Keepers when Deck Keepers are installed.
- Make sure all Non-structural fields are identified and reinforced.
- Make sure Decks are correctly installed and are without damage.
- Ladder must be installed with ladder bracket locked to prevent it from moving or slipping.
- Ladder should be installed at an angle of 4:1 ratio and extend at least 900mm above the Deck.
- An fully filled out Handover Certificate is essential.
- Light duty sign of Void Platform must be attached.
- Make sure Void Platform is not damaged or tampered and is in good condition.





# WARNING

THIS IS A TEMPORARY VOID PLATFORM AREA  
**DO NOT ALTER VOID SYSTEM**

SAFE WORKING LOAD:

**225kg**

( APPROX TWO MEN AND THEIR TOOLS )

1. Make sure you read the Inspection Handbook first.
2. Please check the platform is fully installed before access.
3. Make sure all platform poles are supported by structurally solid floor.
4. Do not remove this warning during in use.
5. Signature is required after installation.

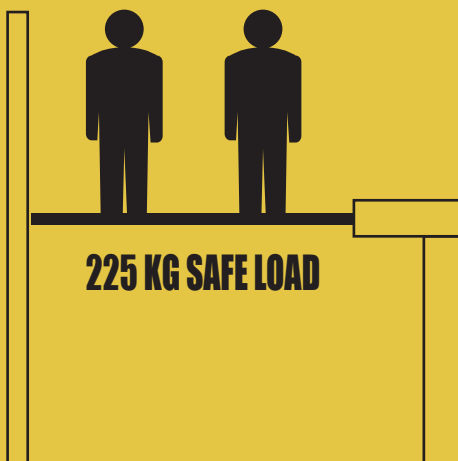

ALL HOOKS CLICK ON TRANSOM POLE

